

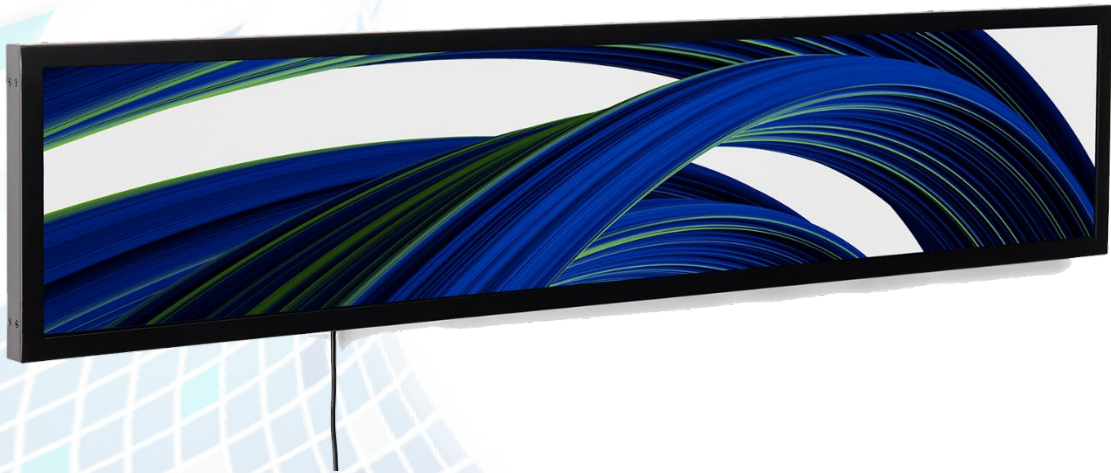

# DISPLAYS2GO

CONNECTING PEOPLE & BRANDS WITH THE WORLD



## DISPLAYS2GO DIGITAL NON-TOUCH STRETCH DIGITAL DISPLAY USER MANUAL

SKUs: DGLCDSTCH28, DGLCDSTCH37

Description: Non-touch digital display with stretched LCD screen



NOTE: Before using the product, please read the instructions carefully.

Do not attempt to disassemble this product. If the product does not work properly, please call our Customer Service Department at 1-844-221-3393.

# TABLE OF CONTENTS

<b>Safety Warnings and Precautions</b> .....	<b>3</b>
Packing List .....	6
Mounting Instructions.....	7
<b>Operation</b> .....	<b>9</b>
Description of Digital Panel Interface .....	9
Power On/Off .....	9
Remote Control of LCD Screen .....	9
Description of Remote Control Buttons .....	10
Uploading and Playing Media.....	11
Connecting to Wi-Fi and Adjust Local Settings.....	12
Screen Rotation.....	12
<b>Technical Specifications</b> .....	<b>13</b>
<b>Troubleshooting Guide</b> .....	<b>14</b>
Cleaning and Maintenance .....	17
Names and Contents of Toxic and Hazardous Substances or Elements in the Product .....	17
FCC Statement .....	18

## SAFETY WARNINGS AND PRECAUTIONS





Thank you for purchasing this product from Displays2go. We have considered the factors to ensure personal safety in product design and have tested rigorously at the factory. However, improper installation and use may result in electric shock and fire.

In order to safely use, maximize performance of the unit and extend the life of the product, please read and follow all instructions carefully before using the product.

Keep the instructions for future reference.

**We strongly recommend using a surge protector, or a power strip with internal circuit breaker to prevent damages to the digital signage.**

### Symbol Legends:

-  **Warning: May cause personal injury or death**
-  **The operation is prohibited**
-  **Caution: May cause damage or property loss**
-  **The operation must be executed**





### If any of the following occurs:

- Power outage or instable voltage.
- Abnormal sound or smell from the unit.
- AC power cord is damaged.
- Digital Signage is damaged due to drop, knock or impact.
- Any liquid or foreign matters fall into the enclosure.

 **Turn off the Digital Signage immediately, pull out the plug from the power outlet, and ask the authorized personnel for maintenance timely.**

-  **If coal gas or other flammable gas leaks, do not pull out the plug of the LCD Digital Signage or other electrical appliances; instead, turn off the gas valve immediately, and open the doors and windows quickly.**

 **WARNING**

-  ● Do not use power supply other than AC 110V, 60Hz.
- Cut off the power supply before connecting or disconnecting any cables.
- Do not place the Digital Signage on any instable positions, or else it may be damaged or cause fire.
- Do not place the Digital Signage in the positions such as:
  1. The environment subject to direct strong sunlight, moisture, extreme temperature or too much dust;
  2. The environment with flammable or explosive materials;
  3. The environment with flammable or corrosive gases;
- Do not use damaged or inappropriate power outlets, and ensure that the plugs and outlets contact properly.
- Do not let dust or metal deposits adhere to the plugs and outlets.
- Do not damage the power cords:
  1. Do not modify the power cords;
  2. Do not place heavy objects on the power cords;
  3. Keep the power cords away from heat source;
  4. Do not pull the cord to remove the plug.
- Do not connect too many plugs to one outlet in parallel, or else it may cause fire due to excessive power consumption.
- Do not approach the Digital Signage with open flame (e.g. a lighted candle), or else it may cause electric shock or fire.
- Do not put any sharp objects, metal or liquid into the vents or let them touch the signal terminals to avoid short circuit, product damage, and electric shock.
- The openings in the enclosure are designed for ventilation and cooling, to ensure long time reliable running of components inside the enclosure and prevent overheating. Do not block the openings while in use.
  
-  Do not touch the plugs with wet fingers, or else it will cause electric shock.
  
-  Do not use the Digital Signage in stormy weather, especially when there is lightning; instead, please disconnect the power and antenna plugs to avoid lightning strike.
  
-  Do not disassemble the Digital Signage without permission, or else it may cause electric shock or fire. Please ask qualified technician for repair.



- Do not let children climb onto the Digital Signage.
- Keep the small parts away from children to prevent them from swallowing.
- If the Digital Signage won't be used for a long time, please turn it off and pull out the power plug.
- To adjust the position of the Digital Signage, please disconnect all power cords and move slowly to avoid tip over.
- Do not scratch or knock the LCD with hard object, or twist and squeeze the LCD.
- Do not turn on the unit immediately when it is moved from a place with low temperature to high temperature, or else it will cause condensation and malfunction.
- Before cleaning the Digital Signage, please pull out the power plug; wipe with soft cloth; do not use industrial chemicals; prevent foreign matters from entering the machine. Improper cleaning (such as cleaning solution, water) may damage the product, erase the printed information, and even cause damage of the components if fluid flows in, resulting in machine failure.
- If the unit displays the same screen for a long time or the moving picture has fixed text or icon, it will leave ghosting on the screen and won't disappear when the unit is turned off; it is normal and isn't covered by the warranty.
- The power of the Digital Signage can be cut off by pulling out the plug.
- If the LCD screen ruptures and the liquid splashes on the skin, please rinse for 15 minutes with clean water immediately, and consult your doctor.
- To carry the Digital Signage with hands, please grab and hold the edges; do not apply pressure on the panel.
- Use the Digital Signage properly: Use in proper lighting conditions; insufficient lighting or long time watching will impair your eyesight.
- When the plug or coupler is used as disconnection device, it should be easy to operate the device.
- Insert the plug into the outlet properly, or else it may cause sparks and fire.
- The technical specifications printed herein and on the packaging are subject to change without prior notice. The Manual may be slightly different from actual operation, and the latter is applicable.

**This Manual is for reference only and is subject to change without prior notice.**

**If you have any questions regarding our products, please visit us at [www.displays2go.com](http://www.displays2go.com) or contact Displays2go customer service at 844-221-3388.**

**Scan QR code to visit product page.**



# PACKING LIST

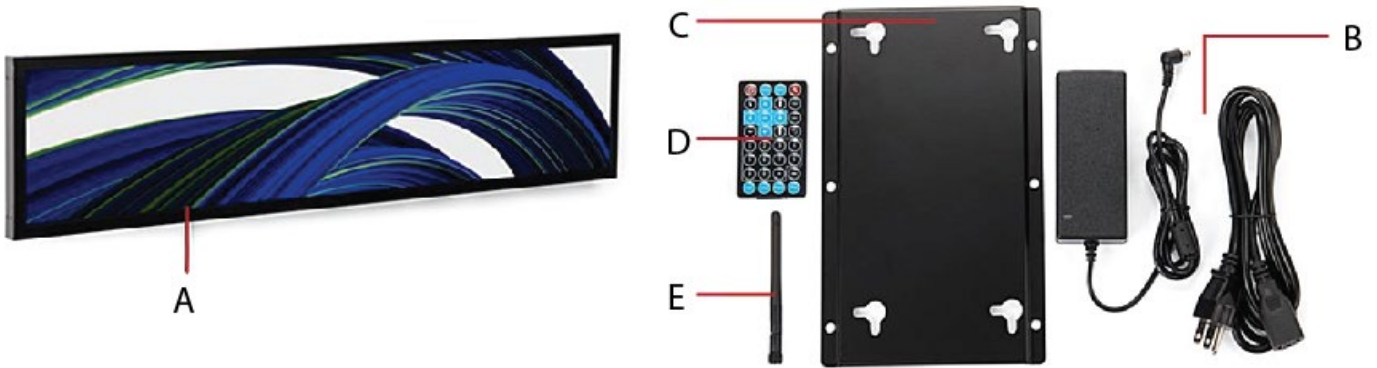

Figure 1.1

PART	QUANTITY
A: Digital Stretch Screen .....	1
B: Power Cord and Adapter.....	1
C: Mounting Plate .....	1
D: Remote Control.....	1
E: Antenna.....	1
<i>Also Included: User Manual</i>	

**Tools Required: Drill, Level (not included)**

**Anchors and bolts recommended for mounting to sheet rock, brick, and wood (not included).**

**TWO people recommended for lifting, moving, and installation.**

## MOUNTING INSTRUCTIONS

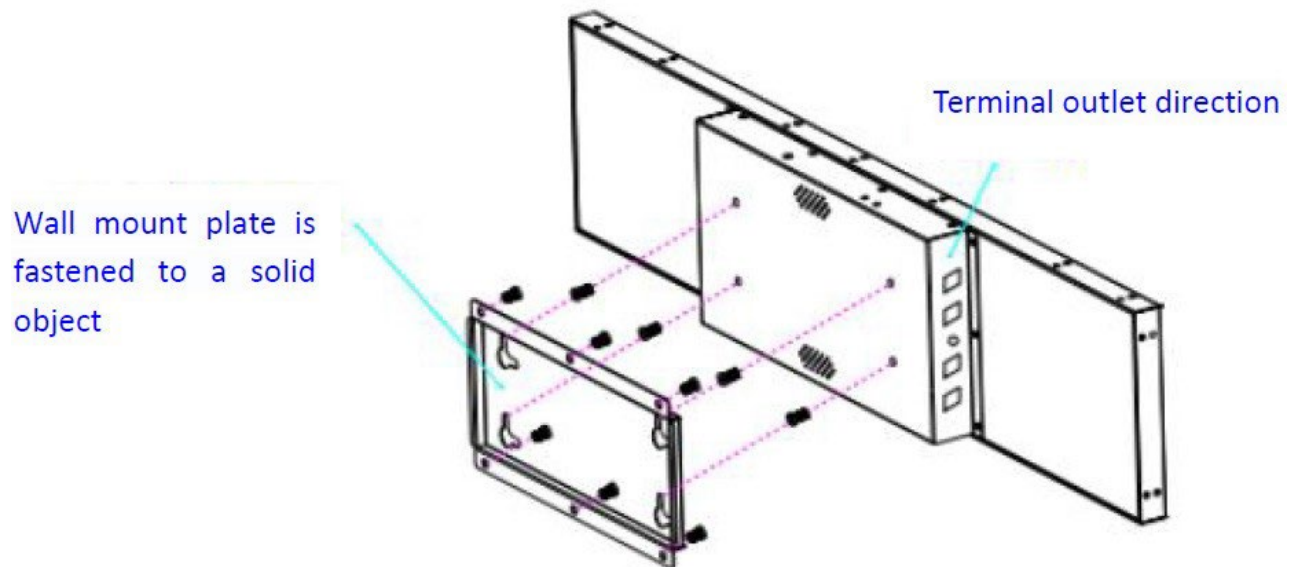

Fig 1.1

**Note:** The load-bearing capacity of the installation surface should be firm and strong with sufficient bearing capacity and should not be less 4 times the actual load-bearing weight. Use anchors and bolts as necessary to securely mount the unit.

1. Locate the mounting plate on the back of the unit.
2. Loosen the hex screws securing it to the frame and gently slide the mounting plate off.
3. Screw the mounting plate to the wall through the outer 6 holes. Use a level to ensure it is straight.

**Note:** Check that the mounting plate is oriented correctly before securing. The widest part of the 4 inner holes should be on top so the unit can slide down and lock into place. Refer to Figure 1.2 on the next page for the correct plate position for landscape and portrait orientation.



Portrait



Landscape

*Fig 1.2*

4. Once plate is securely attached to the wall, lift unit and align the back screws with the 4 center holes on the mounting plate. Slide the unit onto the mounting plate and gently drop the frame into place. Check that it is firmly mounted in place to prevent potential safety hazards.



*Fig 1.3*



# OPERATION

## Description of Digital Panel Interface

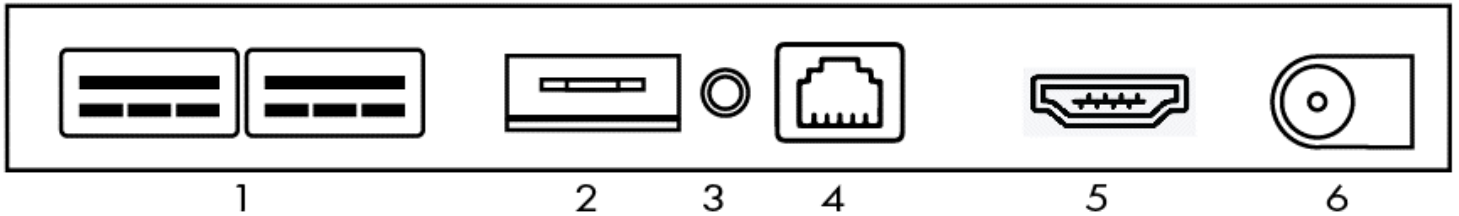



Fig 2.1

1. USB ports (2) 2. MicroSD Card port 3. Audio Input 4. Ethernet Port (RJ45) 5. HDMI Out 6. Power Input

## Power On/Off

- **Power on** by inserting power cord into unit and connecting to outlet.
- **To turn on or off**, use the “” power button on the remote control.
- **To shut down**, press “” power on the remote control, then unplug the unit.

## Remote Control of LCD Screen

### *Precautions*

- Aim the remote control at the receiver window. Do not place any object between the remote control and the receiver window to avoid interference with the normal operation.
- Keep the remote control away from violent vibration. In addition, do not set or place the remote control in direct sunlight, or else the remote control may be deformed by heat.
- The remote control may be invalid when the receiver window of the unit is in direct sunlight or strong lighting; in this case, please adjust the angle of the lighting or the unit or approach the receiver window to use it.
- The distance of remote control will be shortened if the battery voltage is insufficient; in this case,

please replace with new batteries; if the remote control won't be used for a long time or the batteries are run out, please take out the batteries to avoid corrosion due to battery leakage, which will damage the remote control.

- Do not use batteries of different types or mix new batteries with old ones. Always replace the batteries in pairs.
- Do not put the batteries in fire, or charge or disassemble them, or charge, short circuit, disassemble, heat or burn used batteries. Please dispose of waste batteries in accordance with local environmental regulations. Do not expose the batteries in overheated environments such as sunlight and fire.

## Description of Remote Control Buttons

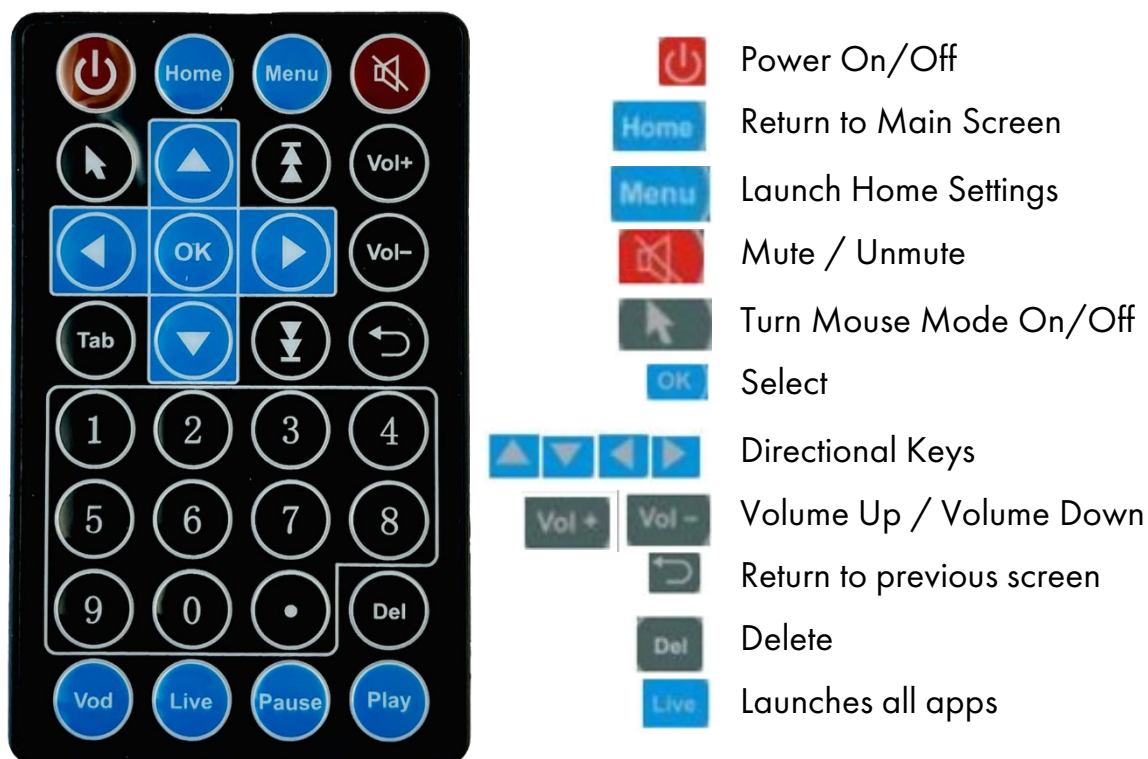

Fig 2.2

**Note:** The remote control supports "mouse mode," or you can also connect a mouse through the USB port of the digital panel.

# Uploading and Playing Media

Check that your desired imagery fits the optimal file dimensions before uploading to the unit. See table below.

## Supported File Formats

Supported Image Files	JPG, BMP, PNG, GIF. The file size should not exceed 2M.	
Supported Video Files	MP4, MKV(264), AVI . The file size should not exceed 2M.	
Supported Audio Files	MP3	
	28"	37"
Active Screen Dimensions	27.5" x 5.2"	37" x 10.5"
Resolution	1920 X 360p	1920 X 375p
Aspect Ratio	16:3	16:3

## Displaying Image or Video

1. Load content onto USB drive and insert into USB port on digital panel.

2. Use the remote to open the Photos app.



**Note:** If USB files do not appear at first, try reinserting the USB.

3. Select the desired image.

4. To minimize Photo Edit widgets at the bottom of the screen, click the empty space between the icons using "mouse mode" on the remote control or with an external mouse. (See figure 2.3)



Fig. 2.3

## Connecting to Wi-Fi and Adjusting Local Settings

**NOTE:** We recommend plugging a keyboard into the USB port to log into Wi-Fi and other applications.

1. Click "Live" to enter Apps List.
2. Click "⚙️" Settings icon.
3. Click Wi-Fi from the list of Settings.
4. Select your Wi-Fi network and enter login credentials.

You can also adjust other local settings from this menu, including Display, Bluetooth, and Notifications.

## Screen Rotation

1. Click "Live" to enter Apps List.
2. Click "⚙️" Settings icon.
3. Click "Screen Orientation" from the list of Settings.
4. Choose a rotation degree.
  - To change the orientation to landscape, choose **180**.
  - To change the orientation to portrait, choose **90**.

The device will restart, then display in the selected rotation.

### *Portrait Mode Media Settings*

	28"	37"
Active Screen Dimensions	360 X 1920p	375 X 1920p

## TECHNICAL SPECIFICATIONS

DISPLAY	28"	37"
Screen Size	28 inches	37.7"
Panel Type	TFT-LCD	TFT-LCD
Machine Dimension	28.7" x 6.4" x 0.5"	38.4" x 8.3" x 0.6"
Active Area	27.5" x 5.2"	37" x 10.5"
Resolution	1920 x 360p	1920 x 375p
View Angle	178/178	178/178
Brightness	500cd/m2	500cd/m2
Contrast Ratio	1200:1	1200:1
Service Lifetime	30,000 hours	30,000 hours
Touch Function	Non-touch	Non-touch
MOTHERBOARD		
OS	Android 11	
CPU	Quad-core 64-bit Cortex-A55, up to 1.8ghz	
Memory	2GB	
Storage	16GB	
Network	Wi-Fi, RJ45, Bluetooth 4.0	
Multimedia	Supports 4K 60fps H. 265/H.264/ VP9 1080P 100fps H.265/H.264 Video decoding	
I/O Ports	DC IN x1, HDMI Out x1, RJ45 x1, Earphone x1, TF card x1, USB OTG x1, OTG x1, USB3.0 x1	
VESA	200x60mm	
Max. Power Consumption Rate	≤45W	≤60W
Standby Power	≤0.5W	
Power Supply	12 V	
Rated Frequency	50/60Hz	
Carton Packing	31.33858 x 6.496 x 9.212 in, 9.9 LBS	41.535 x 6.496 x 11.259 in, 17.2 LBS

## TROUBLESHOOTING GUIDE

ISSUE	PROBABLE CAUSE	SOLUTIONS
No Picture or Sound	<ul style="list-style-type: none"> <li>-Unit is not plugged into the wall.</li> <li>-Power cord not properly connected to the terminal on the back of the unit.</li> <li>-Unit is not powered on.</li> <li>-Wall outlet is not working.</li> </ul>	<ul style="list-style-type: none"> <li>-Check that unit is plugged into wall.</li> <li>-Confirm that the power cord is connected to the terminal on the back of the unit.</li> <li>-Turn the on/off toggle switch to the "on" position.</li> <li>-Unplug unit, wait 20 seconds, plug unit back into outlet and try again.</li> <li>-Make sure that outlet is working by plugging in a different electrical device.</li> </ul>
No Sound (Picture Is Working)	<ul style="list-style-type: none"> <li>-Volume has not been adjusted on the remote control.</li> <li>-Content/Video does not have sound.</li> <li>-Content format is not compatible.</li> <li>-Speakers do not work.</li> </ul>	<ul style="list-style-type: none"> <li>-Adjust volume using the remote control.</li> <li>-Confirm content is one of the following compatible formats: AVI, MPEG4, WMV, MKV, flv, MP3, MP4, MOV.</li> <li>-If unit is connected to Wi-Fi, go to YouTube and play video that has sound as a test.</li> <li>-Unplug unit, wait 20 seconds, plug unit back into outlet and try again.</li> <li>-Try playing the content on a different device (smart phone, computer, or tablet).</li> </ul>
No Picture (Sound Is Working)	<ul style="list-style-type: none"> <li>-Content file is damaged.</li> <li>-Content format is not compatible.</li> <li>-Screen is damaged or defective.</li> </ul>	<ul style="list-style-type: none"> <li>-Confirm content is one of the following compatible formats: AVI, MPEG4, WMV, MKV, flv, MP3, MP4, MOV.</li> <li>-Try playing the content on a different device (smart phone, computer, or tablet).</li> <li>-Unplug unit, wait 20 seconds, plug unit back into outlet and try again.</li> </ul>
Remote Control Not Working	<ul style="list-style-type: none"> <li>-Batteries were not inserted properly.</li> <li>-Batteries are dead.</li> <li>-Standing too close or too far from the unit.</li> </ul>	<ul style="list-style-type: none"> <li>-Check that battery is inserted properly with positive and negative orientation.</li> <li>-Insert new batteries.</li> <li>-Stand within 1 foot of the front of the unit and point the remote directly at the sensor.</li> </ul>

<p>No Wi-Fi Signal</p>	<ul style="list-style-type: none"> <li>-Wi-Fi is not turned on in product settings.</li> <li>-Wi-Fi is not connected to a network.</li> <li>-Low or no signal from the router.</li> <li>-Antenna is missing or not pointed upward.</li> <li>-Damaged PC board.</li> </ul>	<ul style="list-style-type: none"> <li>-Check that Wi-Fi is turned on in settings: <i>Click the settings icon from the Android home screen.</i> <i>Click "Wi-Fi."</i></li> <li><i>Click the on/off icon in the upper right hand corner to turn on Wi-Fi. "On" will appear on the upper left side.</i> </li> <li><i>Select your Wi-Fi network.</i></li> <li>-Confirm that the antenna is in place and pointed upward.</li> <li>-Check that other devices are receiving the signal.</li> <li><i>If other devices are not receiving the Wi-Fi signal, please contact your internet service provider.</i></li> <li>-Unplug or reset the router and wait for 20 seconds. Restart the router and check.</li> </ul>
<p>Parts Missing or Damaged</p>	<ul style="list-style-type: none"> <li>-Parts missed during manufacturing. (No charge for replacements.)</li> <li>-Parts lost or damaged by the customer. (There is charge for replacements.)</li> </ul>	<p>Contact a customer service representative.</p>
<p>Cannot Upload Content</p>	<ul style="list-style-type: none"> <li>-Content format is not compatible.</li> <li>-Content files are too large.</li> <li>-Port being used is defective.</li> <li>-App being used to play content is defective.</li> <li>-Android board is defective.</li> </ul>	<ul style="list-style-type: none"> <li>-Confirm content is one of the following compatible formats: AVI, MPEG4, WMV, MKV, flv, MP3, MP4, MOV.</li> <li>-Confirm file size is less than available space.</li> </ul>

<p>Issues Using Pre-Installed Apps</p>	<ul style="list-style-type: none"> <li>- Mistake in storing content to NAND Flash.</li> <li>- App is defective.</li> <li>- Android board is defective.</li> </ul>	<p>-SlideShow App steps:  <i>Explorer &gt; Select USB &gt; Select Multi &gt; highlight files &gt; Editor &gt; Select Copy &gt; Home &gt; NAND &gt; MediaFolder &gt; Images&gt; Editor &gt; Paste Open SlideShow app and select desired trasiitions, slide time and looping &gt; Play</i></p> <p>-MX Player steps: <i>&gt; Follow same steps as SlideShow App &gt; MediaFolder &gt; Video &gt; Editor &gt; Paste.</i></p> <ul style="list-style-type: none"> <li>o Open MX Player and select video to play.</li> <li>o Loop video: While the video is playing, click on the video and there should be 3 dots in the top right corner. Click on the 3 dots &gt; play &gt; check desired Loop option.</li> </ul>
--	---	---

If all the potential solutions have been tested for a particular issue and problems have not been resolved, contact a customer service representative for guidance.

Contact Information:  
 Website: [www.displays2go.com](http://www.displays2go.com)  
 Phone: 844-221-3388



## Cleaning and Maintenance

1. Avoid strong vibration or impact on the product.
2. Keep the product dry to avoid possible damage by moisture.
3. Don't place the product under direct sunlight which may shorten the service life of the screen.
4. Clean screen and product by using a glass cleaner.
5. If the product will not be used for a long time, pull out the power cord to prevent the internal short circuit or other potential dangers.

## Names and Contents of Toxic and Hazardous Substances or Elements in the Product

Part name	Toxic and hazardous substances or elements					
	Pb	Hg	Cd	Cr <sup>6+</sup>	PBB	PBDE
Display		O	O	O	O	O
Shell	O	O	O	O	×	×
Circuit board assembly *		O	O	O	O	O
Wires	O	O	O	O	O	O
Metal parts	O	O	O	O	O	O
Packaging materials *	O	O	O	O	O	O
Remote control		O	O	O	O	O
Speaker		O	O	O	O	O
Accessories *	O	O	O	O	O	O

\*: Circuit board assembly includes PCB and the electronic elements thereof;

Packaging materials include packaging box, styrofoam, etc.;

Other accessories include instruction manual.

O: the content of the toxic and hazardous substances or elements in the part is lower than the limit specified in GB/T 26572-2011 standard.

×: the content of the toxic and hazardous substances or elements in the part is higher than the limit specified in GB/T 26572-2011 standard.

The table shows that the machine contains harmful substances inside. The data is provided by material suppliers and verified by the company according to the material type. Some materials contain harmful substances that can't be replaced in present technology. We are dedicated to improving this.

The EFUP of the product is ten years. The pollution control label is shown on the right. 

The EFUP is valid only when the user operates in the normal conditions specified in the manual herein.

### *Waste Electrical and Electronic Products Recycling and Disposal Regulations*

To protect the earth, if you do not need this product or its service life expires, please abide by your local *Waste Electrical and Electronic Products Recycling and Disposal Regulations* or send it to qualified local manufacturer for recycling.

**This Manual is for reference only and is subject to change without prior notice.**

**Visit [www.displays2go.com](http://www.displays2go.com) for the latest product information and manual updates.**

## **FCC Statement**

Changes or modifications not expressly approved by the party responsible for compliance could void the user's authority to operate the equipment.

This equipment has been tested and found to comply with the limits for a Class B digital device, pursuant to Part 15 of the FCC Rules. These limits are designed to provide reasonable protection against harmful interference in a residential installation. This equipment generates uses and can radiate radio frequency energy and, if not installed and used in accordance with the instructions, may cause harmful interference to radio communications. However, there is no guarantee that interference will not occur in a particular installation. If this equipment does cause harmful interference to radio or television reception, which can be determined by turning the equipment off and on, the user is encouraged to try to correct the interference by one or more of the following measures:

- Reorient or relocate the receiving antenna.
- Increase the separation between the equipment and receiver.
- Connect the equipment into an outlet on a circuit different from that to which the receiver is connected.
- Consult the dealer or an experienced radio/TV technician for help

This device complies with part 15 of the FCC rules. Operation is subject to the following two conditions (1) this device may not cause harmful interference, and (2) this device must accept any interference received, including interference that may cause undesired operation.